



Contents

1	Safety notes	1
2	Measuring principle	2
3	Specifications	2
3.1	Technical specifications	2
3.2	Delivery scope.....	5
3.3	Optional accessories	5
4	Device description	6
5	Operation	8
5.1	Getting started.....	8
5.2	Switching on the meter	9
5.3	Check before measurement	9
5.4	Calibration	10
5.5	Measurement	10
5.6	Save and delete	11
5.7	Menu structure	12
6	Maintenance and cleaning	14
6.1	Batteries (no rechargeable batteries).....	14
6.2	Troubleshooting	14
6.3	Maintenance of the impact body.....	14
7	Contact	15
8	Disposal	15

1 Safety notes

Please read this manual carefully and completely before you use the device for the first time. The device may only be used by qualified personnel and repaired by PCE Instruments personnel. Damage or injuries caused by non-observance of the manual are excluded from our liability and not covered by our warranty.

- The device must only be used as described in this instruction manual. If used otherwise, this can cause dangerous situations for the user and damage to the meter.
- The instrument may only be used if the environmental conditions (temperature, relative humidity, ...) are within the ranges stated in the technical specifications. Do not expose the device to extreme temperatures, direct sunlight, extreme humidity or moisture.
- Do not expose the device to shocks or strong vibrations.
- The case should only be opened by qualified PCE Instruments personnel.
- Never use the instrument when your hands are wet.
- You must not make any technical changes to the device.
- The appliance should only be cleaned with a damp cloth. Use only pH-neutral cleaner, no abrasives or solvents.
- The device must only be used with accessories from PCE Instruments or equivalent.
- Before each use, inspect the case for visible damage. If any damage is visible, do not use the device.
- Do not use the instrument in explosive atmospheres.
- The measurement range as stated in the specifications must not be exceeded under any circumstances.
- Non-observance of the safety notes can cause damage to the device and injuries to the user.

We do not assume liability for printing errors or any other mistakes in this manual.

We expressly point to our general guarantee terms which can be found in our general terms of business.

If you have any questions please contact PCE Instruments. The contact details can be found at the end of this manual.

2 Measuring principle

An impact body of known weight is propelled against the measuring surface. The hardness value is calculated from the rebound velocity and the impact velocity at 1 mm distance from the measuring surface using the following formula:

$$HL = 1000 \times VB/VA$$

HL-- Hardness according to Leeb

VB-- Rebound velocity

VA-- Impact velocity

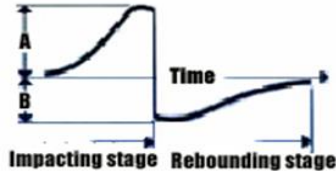

3 Specifications

3.1 Technical specifications

Measurement ranges	170 ... 960 HLD
Accuracy	on 760±30HLD test block = ±6 HLD on 530±40HLD test block = ±10 HLD
Repeatability	on 760±30HLD test block = 6 HLD on 530±40HLD test block = 10 HLD
Measuring direction	360°
Impact device	D-type
Measuring units	HL, HB, HRB, HRC, HRA, HV, HS
Selectable materials	10
Calibration	Possible on included hardness test block
Display	OLED display 128 x 64 pixels
Internal memory	1 ... 373 measurement series (with averaging from 31 measurements) 1 ... 2688 measurement series (with averaging from 1 measurement) approx. 2000 measurement series with AVG after 3 measurements Measurement series consists of mean value / direction of measurement / material / number of measurements for averaging / measured values of each individual measurement
Automatic power-off function	yes
Power supply	2 x CR2016 button cells (not rechargeable)
Operating time	approx. 8 h continuous operation
Interface	Micro USB Note: For software use only
Environmental conditions	0 ... +40 °C / 32 ... 104 °F, ≤90 % RH
Dimensions	145.5 x 32 x 26 mm / 5.73 x 1.26 x 1.02"
Weight	160 g / <1 lb

Measurement ranges according to material and hardness scale

Material	Steel and cast steel	Cast Steel HL / HV / HB / HRC / HS / HRB / HRA
Scale	Rockwell, Brinell, Vickers, Shore	
Measurement range	HRC: 17.9 ... 68,5	
	HRB: 59.6 ... 99,6	
	HRA: 59.1 ... 85,8	
	HB: 127 ... 651	
	HV: 83 ... 976	CWT Steel HL / HV / HRC
	HS: 32.2 ... 99,5	
Material	Cold rolled steel	
Scale	Rockwell, Vickers	
Measurement range	HRC: 20.4 ... 67,1	
	HV: 80 ... 898	
Material	Stainless steel	STAIN. Steel / Stainless Steel HL / HV / HB / HRB
Scale	Rockwell, Brinell, Vickers	
Measurement range	HRB: 46.5 ... 101,7	
	HB: 85 ... 655	
	HV: 85 ... 802	GC Iron Gray Cast Iron HL / HB
Material	Grey cast iron	
Scale	Rockwell, Brinell, Vickers	
Measurement range	HRC: --- HB: 93 ... 334 HV: ---	
Material	Ductile iron	NC Iron HL / HB
Scale	Rockwell, Brinell, Vickers	
Measurement range	HRC: --- HB: 131 ... 387 HV: ---	
Material	Cast aluminium alloy	Cast Alumin HL / HB / HRB
Scale	Rockwell, Brinell	
Measurement range	HRB: 23.8 ... 84,6 HB: 19 ... 164	
Material	Brass	Cooper-Zinc HL / HB / HRB
Scale	Rockwell, Brinell	
Measurement range	HRB: 13.5 ... 95,3 HB: 40 ... 173	
Material	Bronze	Cooper-Alumin HL / HB
Scale	Brinell	
Measurement range	HB: 60 ... 290	
Material	Wrought copper alloy	Wrought Cooper HL / HB
Scale	Brinell	
Measurement range	HB: 45 ... 315	
Material	Wrought steel alloy	Wrought Steel HL / HB
Scale	Brinell	
Measurement range	HB: 143 ... 650	

Chart 2



Specifications D-type impact device

Impact energy	11 Nmm / mJ
Impact body mass	5.5 g
Impact body	Tungsten carbide 3 mm
Application	Suitable for most applications
Test blocks	<500 HLD ~600 HLD ~775 HLD
Measurement range steel	81...654 HB
Max. roughness of the measuring surface	
Peak-to-valley height R_t	10.0 μm
Mean roughness R_a / AA	2.0 μm = N7
Minimum sample mass	
Compact design	5 kg
Coupled	2 kg
Minimum thickness of the sample	
Compact design	25 mm
Coupled	3 mm
Surface layer thickness	≥ 0.8 mm
Test indentation diameter / depth	
300 HV / 30 HRC	0.54 mm / 24 μm
600 HV / 55 HRC	0.45 mm / 17 μm
800 HV / 63 HRC	0.35 mm / 10 μm
Min. Radius of curvature	30 mm
Min. distance of impact points	3 mm
Min. distance to edge	5 mm

Chart 3

Conversion table HLD - Mpa

No.	Material	Hardness (HLD)	Tensile strength σ_b (MPa)
1	Mild Steel	350 ... 522	374 ... 780
2	High-Carbon Steel	500 ... 710	737 ... 1670
3	Cr Steel	500 ... 730	707 ... 1829
4	Cr-V Steel	500 ... 750	704 ... 1980
5	Cr-Ni Steel	500 ... 750	763 ... 2007
6	Cr-Mo Steel	500 ... 738	721 ... 1875
7	Cr-Ni-Mo Steel	540 ... 738	844 ... 1933
8	Cr-Mn-Si Steel	500 ... 750	755 ... 1993
9	Super Strength Steel	630 ... 800	1180 ... 2652
10	Stainless Steel	500 ... 710	703 ... 1676

Chart 4

Note: The chart is for orientation purposes only!

3.2 Delivery scope

- 1 x hardness tester PCE-2550
- 1 x USB connection cable
- 1 x hardness test block
- 1 x cleaning brush
- 1 x support ring \varnothing 14 mm
- 1 x carrying case
- 1 x user manual

3.3 Optional accessories

PCE-HAK, adaptor set, consisting of:

- | | |
|-----------|--|
| HZ12.5-17 | Concave adaptor, 12.5...17 mm (inside) |
| HZ11-13 | Concave adaptor, 11...13 mm (inside) |
| HZ16.5-30 | Concave adaptor, 16.5...30 mm (inside) |

- | | |
|----------|--|
| Z10-15 | Convex adaptor, 10...15 mm (outside) |
| Z14.5-30 | Convex adaptor, 14.5...30 mm (outside) |
| Z25-50 | Convex adaptor, 25...50 mm (outside) |

- | | |
|-----------------|-------------------------------------|
| HK11-13 | Ball adaptor, 11...13 mm (inside) |
| HK12.5-17Sphere | Ball adaptor, 12.5...17 mm (inside) |
| HK16.5-30Sphere | Ball adaptor, 16.5...30 mm (inside) |

- | | |
|----------|---------------------------------------|
| K14.5-30 | Ball adaptor, 14.5...30 mm (external) |
| K10-15 | Ball adaptor, 10...15 mm (external) |





- | | |
|----|------------------|
| UN | Universal holder |
|----|------------------|

4 Device description



1. OLED display
2. Function keys
3. Micro USB interface
4. Impact device
5. Impact body
6. Support ring
7. Clamping slide
8. Trigger button

Function keys

Key	Function
	-On/off -In the menu: back -In measurement mode: save AVG measurement
	-Open menu -In the menu: Select, confirm, scroll through options
	-Cursor right/forward/down -Decrease numbers
	-Cursor left/back/up -increase numbers -In measurement mode: delete measurement

Display (in measuring mode)

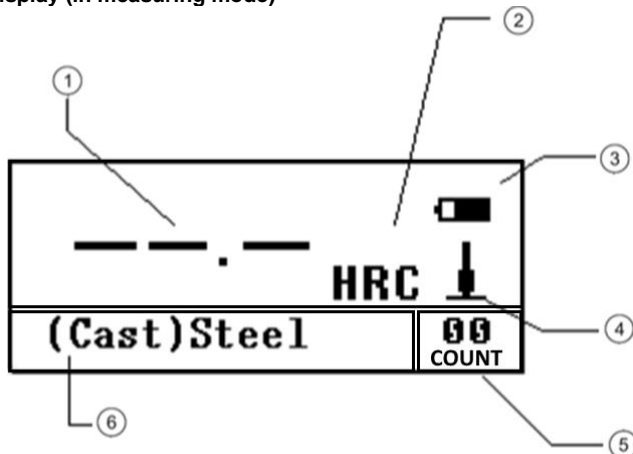

1. Measured value / average value (AVG)
2. Hardness scale
3. Battery level indicator (**no battery / charging via USB not possible**)
4. Direction of impact / direction of measurement
5. Number of measurements carried out for averaging
6. Material

Hint: In measuring mode, the  key can be used to switch directly between the hardness scale / measuring direction / material and number of measurements to be used for averaging.

The changes are made with the  key and confirmed with the  key.

5 Operation

5.1 Getting started

General requirements for the material sample

- The surface temperature of the sample must be below 120 °C.
- The sample must meet the minimum thickness specified in the specifications.
- The surface to be tested should not be too uneven or rough. This could cause errors. The sample being measured should be metallic, smooth and free of grease.
- The surface should not be magnetic.
- If the radius of curvature R of the test surface is smaller than 30 mm, a small support ring should be used.
- The intrinsic magnetism of the sample should be below 30 Gauss.

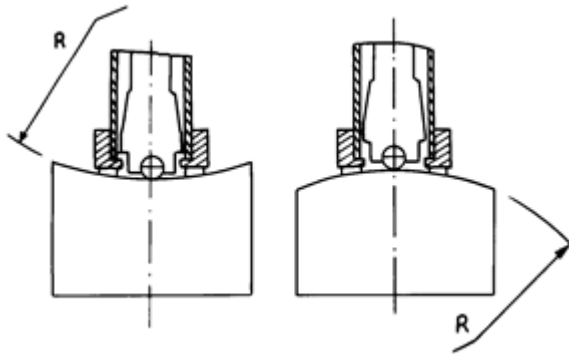

Requirements for the weight of the material sample

For samples which are heavier than five kilogrammes and have a compact design, no support is necessary. Material samples with a weight of two to five kilogrammes but also heavier thin-walled samples should be stabilised by means of a fixing device. This is to prevent the sample from being deformed or displaced when touched. Material samples weighing less than two kilogrammes should be firmly connected with a fixing device of more than five kilogrammes.

Coupling of the material sample to a fixing device/base plate

The contact surface between the material sample and the base plate should be even and smooth. A thin, even layer of coupling gel should be applied between the base plate and the material sample. The sample should then be pressed onto the base plate with circular movements to achieve the best possible contact and distribution of the coupling gel. The direction of impact of the measurement should be perpendicular to the contact surface. The material sample must not have less than a minimum thickness of five millimetres for this method.

Requirements for material samples with hardened surface

Surface and case-hardened steel often gives deviating hardness readings due to its non-homogeneous nature if the material thickness of the hardened layer is less than 0.8 mm.

Note

Good coupling needs experience. Insufficiently coupled samples cause large fluctuations in measured values. Usually, the values are then lower than expected and an unusual noise development occurs (acoustically clearly distinguishable from the measurement on the test block). During the impact, the sample is subjected to a quite large (max. 900 N) but very short-lasting force. Therefore, clamping the material sample in a vice, for example, is unsuitable as a support. The sample can shift minimally. Such faulty measurements can usually be recognised by the large scatter of the measurement results.

5.2 Switching on the meter

To switch on the meter, press the  key.





To switch off the meter, press and hold the  key until "Power OFF" is displayed.

5.3 Check before measurement

Before measuring, check the meter with a hardness test block of known hardness, e. g. the hardness test block that is included. For this purpose, make 5 measurements with vertical impact direction. Keep a minimum distance of 3 mm to the next impact point and 5 mm to the edge. The arithmetic mean of the 5 measurement results is the hardness value. In case of a larger deviation, a calibration can be carried out.

5.4 Calibration

Before using the meter for the first time or if it has not been used for a long time, a calibration should be carried out using the Leeb hardness test block that comes with the meter.

- When switching on, press and hold  and  until calibration mode opens.
- Now make 5 measurements on the hardness test block with vertical impact direction.
- After the 5 measurements, an ACTUAL [Average] and TARGET [Nominal] value appears.
- In case of deviations, the [Nominal] value, which is written on the hardness test block, can be entered with the  key and confirmed with the  key.

Calibration 0/5 times	Calibration 743 2/5 times	Calibration Average=678 Nominal=678
-----------------------------------	---------------------------------------	--

Hint:



The "Nominal" value can only be changed by ± 15 HL. If the deviation is greater, we recommend sending the device to PCE Instruments for calibration.

5.5 Measurement

5.5.1 Hardness measurement

Hint:





Before each measurement, make sure that the measurement settings shown in the display correspond to the application.

- Press down the clamping slide  to clamp the impact body.
- Then press the support ring  vertically (90°) onto the sample surface.
- Then release the impact body with the trigger button .
- We recommend making 5 measurements per test spot.

Hint:

The minimum centre to centre distance between two impact points should not be less than 3 mm and the distance from an impact point to the edge of the sample must not be less than 5 mm.

If a measurement is faulty, it can be deleted by pressing the  key.

The selection is made by pressing one of the two keys  or . Confirm with the  key. A measurement can be cancelled by pressing the  key.



When the set number of measurements has been made, the mean value **AVG** appears.

In AVG mode, the  key can be used to subsequently change the hardness scale. The conversion of the measured values then takes place automatically. An arrow in place of the measured value means that the measured value / hardness scale does not match the conversion range.



5.5.2 Tensile strength measurement (Mpa σ_b)

To measure the tensile strength, select the mode for tensile strength in the "Test Set" menu under "Hard/ σ_b ": σ_b .

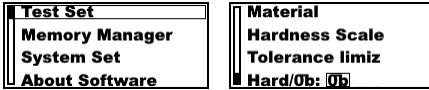

Then set the desired material as well as the impact direction and proceed with the measurement as with the hardness measurement.

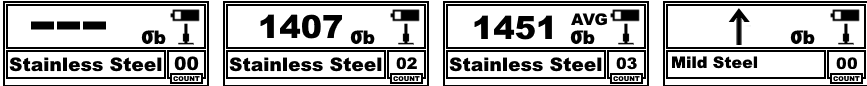



An arrow in place of the measured value means that the measured value is outside the measurement range.

5.6 Save and delete

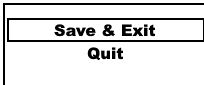
- To **manually save** the measurement series, press and release the  key in AVG mode. The following query then appears in the display:



- The  key can now be used to scroll through the options.
- Confirmation is made by pressing the  key.

Note: Automatic data storage can also be set in the "System Set" menu.

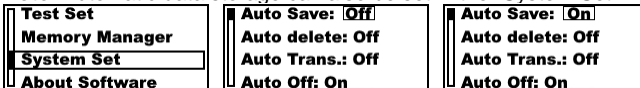

To access the saved values, go to the "Memory Manager" menu with the  key. Here you can retrieve the values. If "No Memory" is set, the memory is cleared.

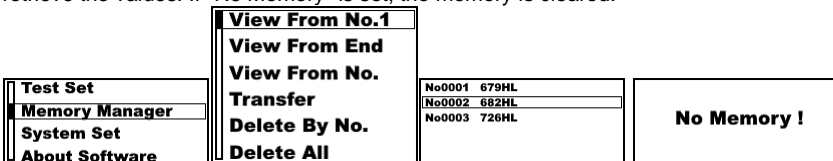







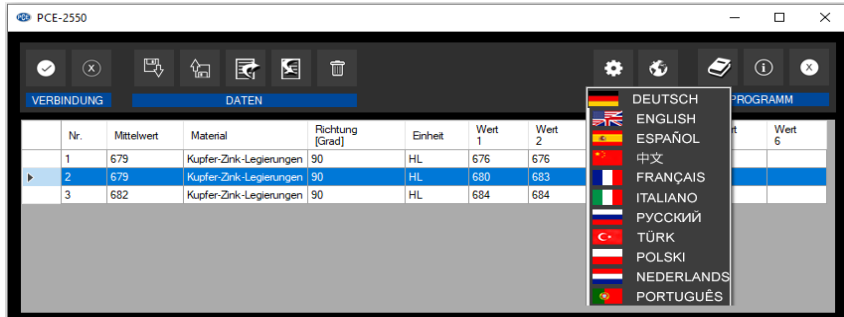





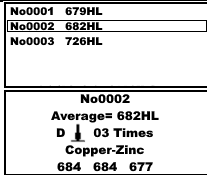

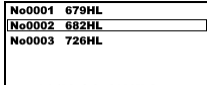

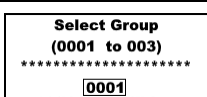
The saved measurement data can be transferred to the PCE-2550 software via the USB interface. The software is available in several languages and can be downloaded free of charge from the PCE Instruments website:

https://www.pce-instruments.com/english/download-win_4.htm

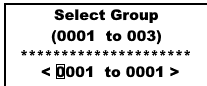

5.7 Menu structure

Test Set			
Impact Direc.	Impact Direction ***** 	Measuring direction / direction of impact	
Average	Mean Times ***** 03	Number of measurements from which the mean value is to be formed. 1 ...31	
Material	see chart 2 and 4	Depending on whether hardness or tensile strength is tested	
Hardness Scale	HL, HV, HB, HRC, HS, HRB, HRA	Depending on the selected material	
Tolerance Limit	Min / Max	0000 ... 9999 **not activated**	
Hard / σ_b :	Hard or σ_b	Hard=hardness measurement σ_b =tensile strength	
Sample Type:	D	Selection of impact body D / DC / D+15 / C / G / DL / E We only offer D	
Standard:	EN	AS / EN	

Memory Manager			
	View From No.1 Display from the first measurement		Selection is made with the  key. Scroll with the  key.
	View From End Display from the last measurement		Selection is made with the  key. Scroll with the  key.
	View From No. Display range selection		  Change number  Change position  Confirm
	Transfer Measurement data transfer to the PCE-2550 software		
	Delete By No. Deletion of certain measurements		  Change number  Change position  Confirm
	Delete All Delete all measurements		
System Set			
	Auto Save:	Off / On	Automatic data storage
	Auto Delete:	Off / On	Automatic deletion
	Car Trans..:	Off / On	No function
	Auto Off:	Off / On	Automatic power off
About Software			
	SoftWare Version Ver1.02 Code: PCE-190812SN A11011909019		

6 Maintenance and cleaning

6.1 Batteries (no rechargeable batteries)

When the  icon flashes, the batteries must be replaced. To do this, unscrew the cover at the back and remove the old batteries. Replace them with 2 new CR2016 button cells.

6.2 Troubleshooting

Problem	Cause	Solution
Meter does not switch on	Batteries flat	Replace the batteries.
No measured value is displayed	No measurement	Check the release and course of the impact body. If it hits the test spot without any problems, contact our service department.
The measured value is inaccurate	Calibration expired	Calibrate the meter.

6.3 Maintenance of the impact body

No special maintenance is required, apart from occasional (after approx. 1000 ... 2000 measurements) cleaning of the impact body and the guide tube. To do this, unscrew the support ring and remove the impact body. The impact body must be cleaned of dirt and metal dust. Clean the guide tube with the brush provided. Do not put oil or grease on the impact body. The impact body must be loosened after each use.

The impact body is excluded from the warranty!

7 Contact

If you have any questions, suggestions or technical problems, please do not hesitate to contact us. You will find the relevant contact information at the end of this user manual.

8 Disposal

For the disposal of batteries in the EU, the 2006/66/EC directive of the European Parliament applies. Due to the contained pollutants, batteries must not be disposed of as household waste. They must be given to collection points designed for that purpose.

In order to comply with the EU directive 2012/19/EU we take our devices back. We either re-use them or give them to a recycling company which disposes of the devices in line with law.

For countries outside the EU, batteries and devices should be disposed of in accordance with your local waste regulations.

If you have any questions, please contact PCE Instruments.





PCE Instruments contact information

Germany

PCE Deutschland GmbH
Im Langel 26
D-59872 Meschede
Deutschland
Tel.: +49 (0) 2903 976 99 0
Fax: +49 (0) 2903 976 99 29
info@pce-instruments.com
www.pce-instruments.com/deutsch

United Kingdom

PCE Instruments UK Ltd
Unit 11 Southpoint Business Park
Ensign Way, Southampton
Hampshire
United Kingdom, SO31 4RF
Tel: +44 (0) 2380 98703 0
Fax: +44 (0) 2380 98703 9
info@pce-instruments.co.uk
www.pce-instruments.com/english

The Netherlands

PCE Brookhuis B.V.
Institutenweg 15
7521 PH Enschede
Nederland
Telefoon: +31 (0)53 737 01 92
info@pcebenelux.nl
www.pce-instruments.com/dutch

France

PCE Instruments France EURL
23, rue de Strasbourg
67250 Soultz-Sous-Forets
France
Téléphone: +33 (0) 972 3537 17
Numéro de fax: +33 (0) 972 3537 18
info@pce-france.fr
www.pce-instruments.com/french

Italy

PCE Italia s.r.l.
Via Pesciatina 878 / B-Interno 6
55010 Loc. Gragnano
Capannori (Lucca)
Italia
Telefono: +39 0583 975 114
Fax: +39 0583 974 824
info@pce-italia.it
www.pce-instruments.com/italiano

United States of America

PCE Americas Inc.
1201 Jupiter Park Drive, Suite 8
Jupiter / Palm Beach
33458 FL
USA
Tel: +1 (561) 320-9162
Fax: +1 (561) 320-9176
info@pce-americas.com
www.pce-instruments.com/us

Spain

PCE Ibérica S.L.
Calle Mayor, 53
02500 Tobarra (Albacete)
España
Tel. : +34 967 543 548
Fax: +34 967 543 542
info@pce-iberica.es
www.pce-instruments.com/espanol

Turkey

PCE Teknik Cihazları Ltd.Şti.
Halkalı Merkez Mah.
Pehlivan Sok. No.6/C
34303 Küçükçekmece - İstanbul
Türkiye
Tel: 0212 471 11 47
Faks: 0212 705 53 93
info@pce-ctihazlari.com.tr
www.pce-instruments.com/turkish