

User Manual



EPIRB3 Pro

Category 1

Emergency Position Indicating Radio Beacon

with AIS and RLS

English



© 2022 Ocean Signal Ltd

The technical data, information and illustrations contained in this manual were believed to be correct at the time of print. Ocean Signal Ltd reserve the right to change specifications and other information contained in this manual as part of our continual improvement process.

No part of this manual may be reproduced, stored in a retrieval system or transmitted in any form, electronic or otherwise, without the prior permission of Ocean Signal Ltd.

No liability can be accepted for any inaccuracies or omissions in this manual.

Ocean Signal® and SafeSea® are registered trademarks of Ocean Signal Ltd.

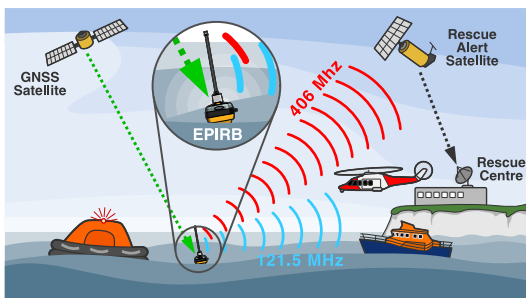

For ease of access please record details of your EPIRB3 Pro here:

Owners Name:

Vessel Name:

Beacon HEX ID (UIN):

IN CASE OF EMERGENCY

USE ONLY IN SITUATIONS OF
GRAVE AND IMMINENT DANGER
MANUAL ACTIVATION



1

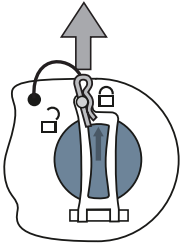

2

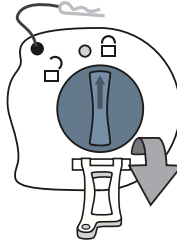

3

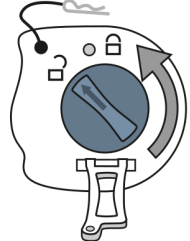

4

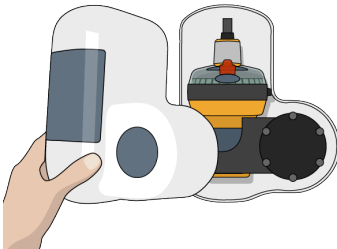

5



6



7



8



1. ABOUT YOUR EPIRB

1.1 COSPAS/SARSAT System

The basic Cospas-Sarsat concept is illustrated in the figure below.

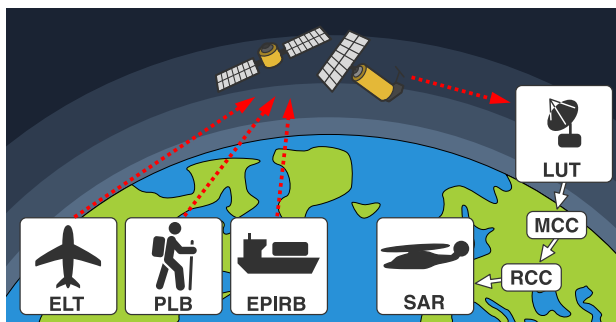

The System is composed of:

- distress radio beacons (ELTs for aviation use, EPIRBs for maritime use, and PLBs for personal use) which transmit signals during distress situations
- instruments on board satellites in geostationary and low-altitude Earth orbits which detect the signals transmitted by distress radio beacons
- ground receiving stations, referred to as Local User Terminals (LUTs), which receive and process the satellite downlink signal to generate distress alerts
- Mission Control Centers (MCCs) which receive alerts produced by LUTs and forward them to Rescue Coordination Centers (RCCs), Search and Rescue Points Of Contacts (SPOCs) or other MCCs

The Cospas-Sarsat System includes two types of satellites:

- satellites in low-altitude Earth orbit (LEO) which form the LEOSAR System
- satellites in geostationary Earth orbit (GEO) which form the GEOSAR System

The future Cospas-Sarsat System will include a new type of satellite in the medium-altitude Earth orbit (MEO) which will form the MEOSAR System. The EPIRB3 Pro is fully compatible with the new MEOSAR satellites.

1.2 Return Link Service

The Galileo Return Link Service (RLS) is a free-of-charge global service available to Cospas-Sarsat RLS compatible beacons. The new functionality, currently offered uniquely by Galileo, enables a communication link that relays a Return Link Message (RLM) back to the originating beacon through the Galileo Navigation Signal in Space.

The RLS feature is an indication on the EPIRB3 Pro that confirms to the User that the distress signal from the EPIRB has been localised by the Cospas-Sarsat system and is being sent to the SAR authorities. It does NOT mean that a search and rescue mission has been launched, but only confirms that the distress alert has been received by the Cospas-Sarsat system and is being routed to the appropriate SAR agencies.

The RLS aims to send an acknowledgment to the beacon within 30 minutes following activation (the response may not be received by the beacon for significantly longer).

RLS is an optional function and may not be permitted in all countries.

The full RLS specification can be found here:

<https://gsc-europa.eu/sites/default/files/sites/all/files/Galileo-SAR-SDD.pdf>

1.3 AIS System

AIS systems operate on VHF radio bands and transceivers are fitted to all commercial shipping and an ever growing number of recreational vessels globally. Shortly after activation, an AIS EPIRB device will activate an alarm on all AIS equipped vessels within VHF range alerting them to the fact that a person is in the water needing assistance. Often it is a vessel in the close vicinity of an incident that is able to react and effect a rescue quicker than the emergency services.

Emergency service craft are fitted with AIS receivers allowing them to pinpoint a casualty in the water more precisely than any other system.

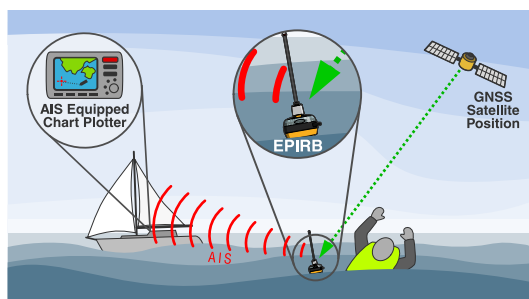

1.	ABOUT YOUR EPIRB	4
1.1	COSPAS/SARSAT System	4
1.2	Return Link Service	5
1.3	AIS System	5
2.	GENERAL	7
2.1	Introduction	7
2.2	Exposure to RF Electromagnetic Energy	7
2.3	Warnings	7
2.4	What's in the Box	8
2.5	Operating Modes	8
3.	EPIRB3 PRO OVERVIEW	9
4.	INSTALLATION	10
4.1	Location	10
4.2	Removing the EPIRB from the Auto Release Housing	11
4.3	Mounting Dimensions	12
4.4	Fitting the Auto Release Housing	12
4.5	Loading the EPIRB3 Pro into the housing	14
5.	OPERATION	16
5.1	Manual Activation	17
5.2	Optical Indications on activation	19
5.3	Deactivation	20
6.	FALSE ALERTS	20
7.	TESTING	21
7.1	NFC and Mobile App.	21
7.2	Beacon Test	22
7.3	GNSS Test	24
8.	BEACON REGISTRATION	25
8.1	Advice to owners of EPIRBs	25
8.2	Country Specific Registration Information	25
8.3	UNREGISTERED BEACON	26
9.	APPENDIX	27
9.1	Maintenance	27
9.2	Batteries	29
9.3	Decommissioning and Disposal	29
9.4	Transport	30
9.5	HRU Replacement	31
9.6	Specifications	32
9.7	Approvals	33
9.8	Spares	33
10.	WARRANTY INFORMATION	35
10.1	Limited Warranty	35
10.2	Extended Warranty	35

2. GENERAL

2.1 Introduction









This manual provides valuable information for the installation, operation and routine maintenance of the EPIRB3 Pro complete with the included Auto Release Housing.

Please read this manual completely before using your EPIRB3 Pro.

2.2 Exposure to RF Electromagnetic Energy

This product complies with EN62479 (EU) and RSS-102 (Canada).

2.3 Warnings

-  It is a legal requirement to register your EPIRB3 Pro with your National Authority.
-  Only use your EPIRB3 Pro in a situation of grave and imminent danger.
-  Deliberately misusing your EPIRB3 Pro or setting it off accidentally may result in prosecution and a fine.
-  Contains Lithium batteries:
 - store between **-30°C (-22°F) to +70°C (+158°F)**
 - If the EPIRB3 Pro is stored at higher temperatures the battery life may be degraded and should be replaced earlier than the date stated. Failure to do this may result in the EPIRB3 fulfilling the stated 48hr operating life. The effect is more pronounced as the temperature increases.
 - **DO NOT ATTEMPT TO REPLACE THE BATTERIES YOURSELF**
unauthorised opening and battery replacement may put your life at risk.
 - do not short circuit, incinerate or recharge.
-  Please see section 9.4 for information on safe transportation.
-  The battery in your EPIRB3 Pro should be replaced immediately if it has been activated, or if the test indicator shows the battery as 'used', or if the expiry date marked on the unit has been exceeded.
-  Battery replacement must be carried out at an Ocean Signal authorised battery replacement centre using manufacturer supplied battery components. The EPIRB3 Pro is supplied with an automatic release housing for external installation only. See the installation guidelines in section 4 for further information.
-  Please read these instructions carefully. Failure to follow the guidance in this manual may result in loss of warranty.

2.4 What's in the Box

1. EPIRB
Cat1 Assembly
2. User Guide &
Labels
3. Adapter Bracket
& Mounting Screws (x6)

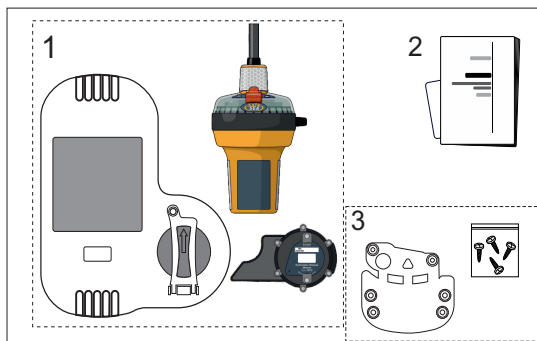

2.5 Operating Modes

Your EPIRB3 Pro may be operated in a variety of modes.

2.5.1 Automatic Release and Activation



Should the vessel sink the EPIRB3 Pro will automatically be released from its housing and float to the surface. Contact with the water will automatically activate the EPIRB3 Pro.

2.5.2 Manual activation on deck



When deploying the EPIRB3 Pro on a deck, ensure it is vertical and clear of obstructions that might impede a clear view of the sky. If the unit is thrown into the water then it will activate automatically.

2.5.3 Manual activation in a life raft



The EPIRB3 Pro may be deployed from a life-raft, where it should be held in a vertical position so that there is a clear view of the sky. It is recommended that the EPIRB3 Pro is held outside of the canopy. The EPIRB3 Pro can also be tethered to the life-raft and allowed to float alongside.

3. EPIRB3 PRO OVERVIEW



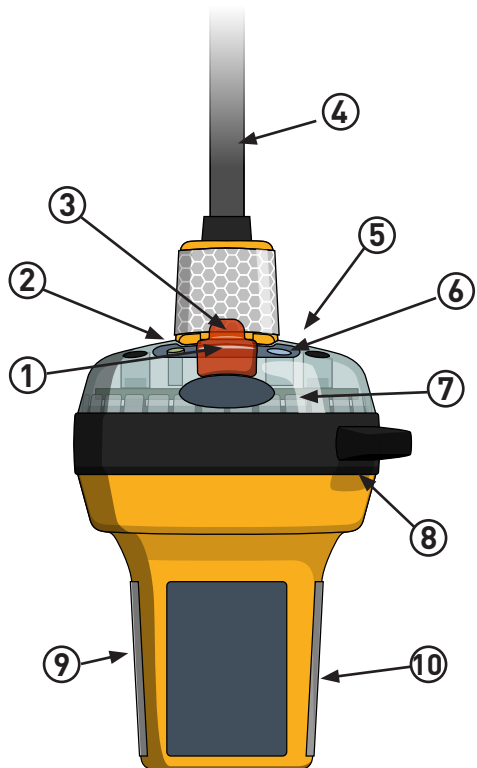



- 1) **ON/OFF** Key (Under flap)
- 2) Indicator LED
- 3) Break Off Tab
- 4) Antenna
- 5) Strobe light
- 6) **TEST** Key
- 7) NFC Antenna
- 8) Lanyard under rubber band
- 9) Serial Number/ UIN Label
- 10) Programming Details Label



 **The lanyard is provided to attach the EPIRB3 Pro to the life raft or your person, once it is activated. Do not use it to attach it to the ship, as this may result in the loss of the EPIRB3 Pro if the vessel sinks.**

 **It is important that the vessel details are marked on the EPIRB3 Pro. Please use a fine tip UV resistant indelible pen to clearly mark the MMSI, Vessel Name and Call Sign in the spaces provided. Cover this label with the clear protective label provided to protect the text from wear.**

4. INSTALLATION

-  Failure to follow the following installation guidelines may cause the EPIRB3 Pro to operate incorrectly.
-  Do not mount the EPIRB3 Pro closer than 1.0 metre to any steering compass as this may affect the accuracy of the compass.
-  Keep the EPIRB3 Pro away from any strong magnetic sources such as loudspeakers, compass compensation magnets, etc.
-  To prevent possible build up of ice within the Auto Release Housing mount the unit to a vertical surface
-  Do not install or operate in a location subject to high intensity RF fields (e.g. radar or communications antennas)
-  GNSS operation may be impaired if operated within 10m of GMDSS sat-com systems.

4.1 Location

The location selected must be sufficiently robust to support the weight of the entire unit. Exposure to the elements and surrounding hazards along with vibration should also be taken into consideration when choosing the location. Ensure that the mounting location allows easy access to the EPIRB3 Pro for maintenance and servicing.

To ensure that the EPIRB3 Pro will always float free from the sinking vessel ensure that the Auto Release Housing is located high up on the superstructure, free from any obstructions and located in a position where it will not be trapped, regardless of the angle of the sinking vessel. Always leave at least 150mm (6") around the Auto Release Housing to ensure the cover releases reliably.

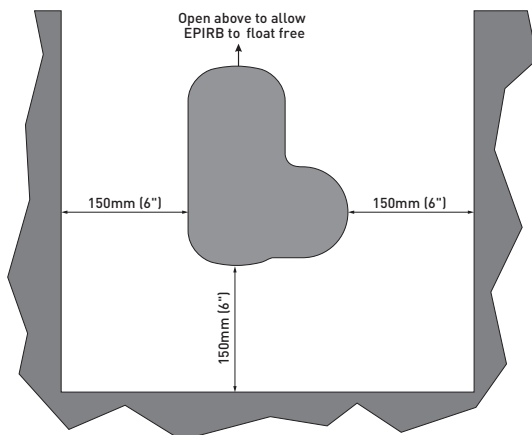

4.2 Removing the EPIRB from the Auto Release Housing

Prior to installation the EPIRB must be removed from the housing.

1. Remove the pin
2. Release the safety catch from the release knob
3. Turn the knob anti-clockwise to release the cover

①

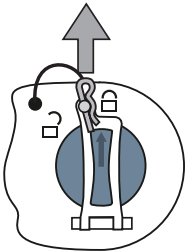

②

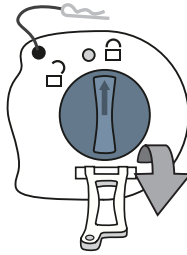

③

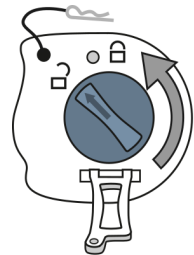

4. Pull the cover free and place to one side.
5. Lift the Hydrostatic clip and remove the EPIRB3 Pro from the mount

④

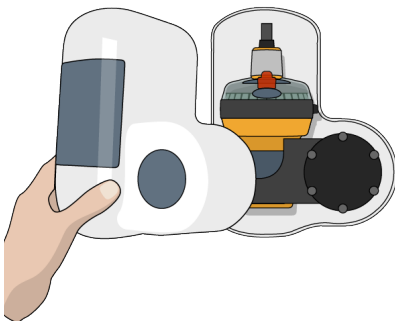

⑤



4.3 Mounting Dimensions

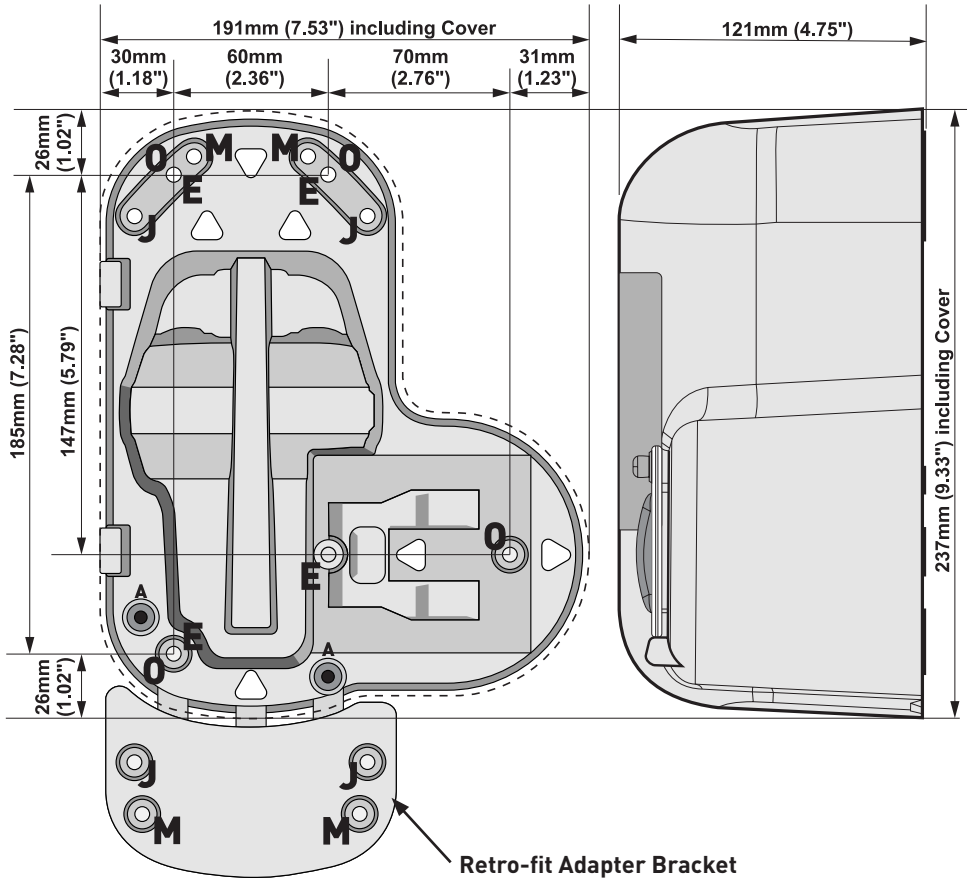

4.4 Fitting the Auto Release Housing

Using the dimensions shown, use four of the No10 x 1" screws supplied to secure the Auto Release Housing to the chosen structure using the holes marked 'O' on the diagram. For mounting surfaces constructed of a material unsuitable for these screws use suitable fixings (not supplied).

Fixing holes 'E' are provided to match the Ocean Signal E100/E100G if this product is being used to replace these older models.

4.4.1 Retro-fit Adapter Bracket

The EPIRB3 Pro Auto Release Housing comes with an Adapter Bracket that allows easy installation where older EPIRBs from other manufacturers have been fitted. Attach the Adapter Bracket to the Auto Release Housing using the two holes 'A' and two of the No10 x 1" screws supplied.

The Adapter Bracket provides fixing holes suitable for:

- **J** - Jotron Tron 60S
- **M** - McMurdo E5/G5

4.5 Loading the EPIRB3 Pro into the ARH1 Auto Release Housing

⚠ When replacing the EPIRB3 Pro in the Auto Release Housing please ensure that the unit is clean and dry. The area around the activation controls and the lanyard should be free from water and dirt to ensure reliable operation.

The EPIRB3 Pro is held in place inside the Auto Release Housing by the HR1E Hydrostatic Release Unit (HRU) which locks into position using a spring.

Following installation (or after maintenance, testing, etc.) it is necessary to replace the EPIRB3 Pro into the Auto Release Housing.

1. Pull back the HRU
2. Load the EPIRB3 Pro, controls facing up, into the location seat, ensuring to carefully fold the antenna back behind the EPIRB3 Pro.
3. Gently lower the HRU back into the locked position - this holds the EPIRB3 Pro securely in place.

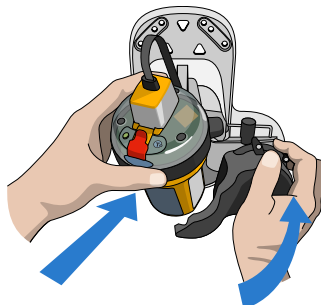

4. When installing your EPIRB3 Pro for the first time, the expiry date on the HRU label (shown below) should be completed with an indelible pen .

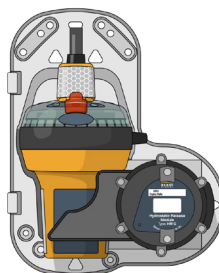

NOTE: The expiry date should be two years from the date of installation on to your vessel, but no more than three years from the date of manufacture.

5. Clearly mark the expiry date on to the separate label provided for use on the outside of the Housing.



6. Place the housing cover over the back plate, by placing the locating holes (on the side of the housing) over the clips.

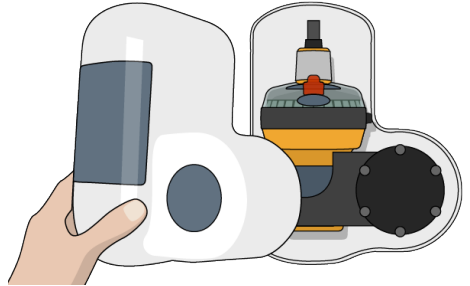

7. Push and rotate the housing release knob into the locked position (right).
8. Fold the latch up over the release knob
9. Insert the pin to retain the latch

7 Push & Turn the knob

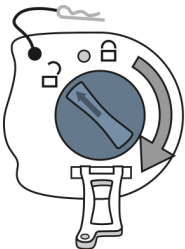

8 Close the catch

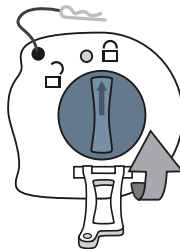

9 Insert the pin

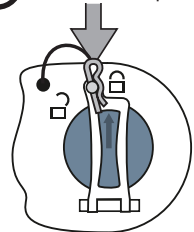

10. Complete the provided identification label using a UV stable indelible pen. Fit to the side of the ARH1 cover left hand side in an easily visible position and use the clear protective label to cover it. Fix the HRU expiry label to the housing in the rectangular recess and cover with the clear protective label.

5. OPERATION

IN CASE OF EMERGENCY



**USE ONLY IN SITUATIONS OF
GRAVE AND IMMINENT DANGER**



The EPIRB3 Pro is designed for best operation while floating in water. If used in other situations ensure that the EPIRB3 Pro is placed in the open, clear of any cover and kept upright. Do not place the EPIRB3 Pro close to large structures or under cover.

In the event that the vessel sinks the EPIRB3 Pro will automatically be released from the housing and will activate on contact with the water.

In the case of abandoning ship, if possible, recover the EPIRB3 Pro and tie to the survival craft or person using the lanyard. For optimum operation, it is recommended that the EPIRB3 Pro be tied to the raft with the lanyard and floated in the sea.



The EPIRB3 Pro is prevented from accidental activation while mounted in the Auto Release Housing.



For manual activation the EPIRB3 Pro MUST be removed from the housing and the antenna allowed to deploy fully.

5.1 Manual Activation

5.1.1 Removing from the Enclosure

1. Remove the pin
2. Release the safety catch from the release knob
3. Turn the knob anti-clockwise to release the cover

①

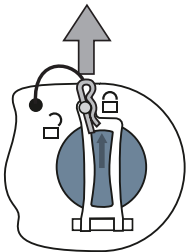

②

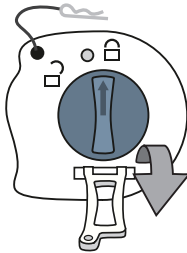

③

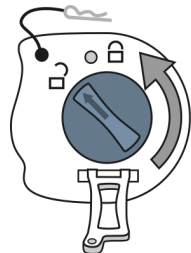

4. Pull the cover free and discard.
5. Lift the Hydrostatic clip and remove the EPIRB3 Pro from the mount

④

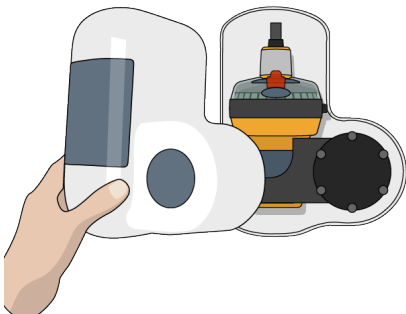

⑤



5.1.2 EPIRB3 Pro Manual Activation

1. Break off the red protective tab from the top of the EPIRB3 Pro.
2. Lift the yellow flap up to expose the Red ON/OFF button.
3. Press and hold the red button for 1 second to activate.
(Until the green LED starts to flash)

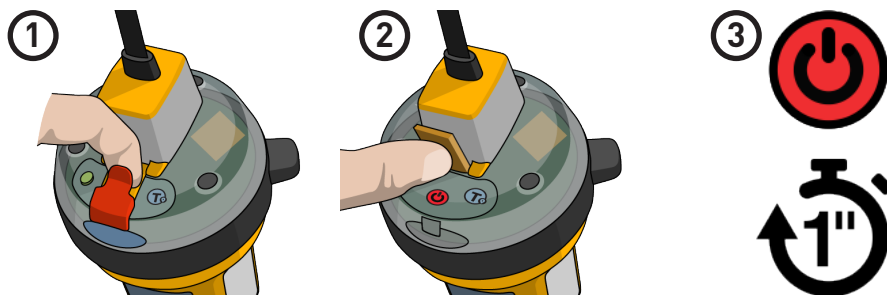

The EPIRB3 Pro will now be operational. The strobe lights will begin to flash at a rate of once every 2.5 seconds as soon as the unit is activated.

For best performance it is important that the EPIRB3 Pro is in an upright position with a clear view of the sky and as far away from any metallic structures as possible.

The EPIRB3 Pro contains a GNSS receiver. Ensure that the GNSS antenna is not obstructed and has a complete, unobstructed view of the sky – as indicated on the top of the EPIRB3 Pro.

A lanyard is provided to tether the EPIRB3 Pro to the lifeboat or life raft to ensure that it does not drift away. Make sure this is firmly attached.





5.1.3 EPIRB3 Pro Automatic Operation

The EPIRB3 Pro will sense when it has been placed in water and automatically begin to operate after a short delay, in the same manner as described above.









⚠ If the EPIRB3 Pro is mounted in the Auto Release Housing this function is disabled until the EPIRB3 Pro has been released.

If the EPIRB3 Pro is mounted in the Auto Release Housing in the event that the vessel sinks the EPIRB3 Pro will automatically be ejected from the housing allowing it to float to the surface and begin transmission.









5.2 Optical Indications on activation

- The LED will illuminate green  (blue  if RLS is enabled) for 1 second.
- The strobe light  will start flashing.
- Within 1 minute* of activation, the indicator LED will flash a quick burst of 5 indicating 406MHz transmission.
- Following the first 406MHz transmission the LED will flash 8 times** (green  if a GNSS fix has been acquired or red  if there is no fix) indicating AIS transmission.

5.2.1 LED Indications with RLS Enabled

LED	When	Transmit	GNSS	RLS
(x1) 	Every 5 s		Searching	
(x3) 	Once		Fix acquired	
(x5) 	At transmit	406MHz	No Fix	Request sent
(x5) 	At transmit	406MHz	Fix acquired	Request sent
(x8) 	At transmit*	AIS	No Fix	
(x8) 	At transmit*	AIS	Fix acquired	
(x1) 	Every 2.5 s**	121MHz		Reply not received
(x1) 	Every 2.5 s**	121MHz		Reply received
(x1) 	Every 2.5 s			

5.2.2 LED Indications for units configured with non-RLS Protocol

LED	When	Transmit	GNSS
(x1) 	Every 5 s		Searching
(x3) 	Once		Fix acquired
(x5) 	At transmit	406MHz	No Fix
(x5) 	At transmit	406MHz	Fix acquired
(x8) 	At transmit*	AIS	No Fix
(x8) 	At transmit*	AIS	Fix acquired
(x1) 	Every 2.5 s**	121MHz	
(x1) 	Every 2.5 s		

* The AIS transmissions will show as 8 flashes (1 every 2 seconds) as a sequence repeated once every minute

** The 121MHz Homer will not transmit until after the first 406MHz transmission.

5.3 Deactivation

5.3.1 Deactivation if Manually Activated

If the EPIRB3 Pro has been inadvertently activated or the emergency situation has passed, it can be turned off simply by pressing and holding for 1 to 2 seconds the ON/OFF  key. It is not possible for the user to replace the red protective cover. Return the EPIRB3 Pro to an Ocean Signal authorised service centre for checking and replacement.

5.3.2 Deactivation if Automatically Activated

If the EPIRB3 Pro was automatically activated by placing in water, remove from the water and dry. The EPIRB3 Pro will automatically switch off after approximately 30 seconds.

6. FALSE ALERTS

False alerts are a serious problem - they cause valuable resources to be diverted away from real emergency situations. If a false alert is initiated, by any means, it is important to contact the nearest search and rescue authority and inform them of the false alert.

Report the following information:

1. EPIRB3 Pro UIN.
2. Date, time and duration.
3. Cause of activation.
4. Location when the alert was activated.
5. Location at time of deactivation.

If the EPIRB3 Pro was activated by mistake then turn it off. The first emergency transmission will not occur for approximately 50 seconds. If the unit is turned off within this time then EPIRB3 Pro will not have sent an emergency distress alert.

The EPIRB3 Pro is fitted with water activation contacts. Although the Auto Release Housing is designed to prevent accidental activation in heavy seas and adverse weather conditions, if the EPIRB3 Pro is not correctly fitted in its housing it is possible that this may cause a false alert situation.

If the unit has been dropped into the water then remove from the water and dry the case. Wait approximately 30 seconds for the water contacts to de-activate. If the unit is still flashing after this period, check that the unit has not been manually activated; if so then follow the procedure to manually switch the EPIRB3 Pro off.

Once the EPIRB3 Pro is switched off, it is advisable to carry out a self test before replacing the EPIRB3 Pro into the Auto Release Housing.



Should the EPIRB3 Pro fail to deactivate, bend the antenna down and completely wrap in several layers of aluminium foil, or place in a metal container with a tightly fitting lid.

7. TESTING

Routine testing of your EPIRB3 Pro is recommended to ensure it is in good working order if needed in an emergency. Monthly testing is recommended, but remember that each test will reduce the battery capacity slightly and reduce the operating time of your EPIRB3 Pro during an emergency.

7.1 NFC and Mobile App.

The EPIRB3 Pro is capable of connection to devices using Near Field Communication (NFC). NFC technology allows communication between two electronic devices over a distance of 4cm (1.5") or less. The benefit of using NFC in the EPIRB3 Pro is that the power used for communication comes from the mobile device and not the beacon.





The Ocean Signal mobile App allows a user to access the EPIRB3 Pro and see the programmed details and the latest test results giving a clear indication of the beacon's condition.

Download the App. here: Android  iOS 





To use the App touch your mobile device to the top of the EPIRB3 Pro where you see "NFC".



7.2 Beacon Test













-  Ensure the antenna is free and above the EPIRB3 Pro before commencing the test. Fold the antenna back behind the EPIRB3 Pro as you replace it in the housing.
-  Because the test transmits a short burst on the aircraft distress frequency of 121.5MHz, please only carry out this test in the first five minutes of each hour.
-  It is recommended to test your EPIRB3 Pro once a month.
-  A magenta or amber test result indicates the battery has been used for over two hours or the recommended number of tests has been exceeded. The EPIRB3 Pro will still operate normally in distress, but the battery should be replaced to ensure the full operating life when your EPIRB3 Pro is needed.

7.2.1 Functional Test













To test your EPIRB3 is functioning correctly, press and hold the TEST  key for 1 to 2 seconds. The LED will illuminate red  to indicate the key has been pressed, then start flashing. Release the TEST  key now. After a short pause the strobe  will flash and the indicator LED will produce a flash sequence.





The flash sequence indicates the total number of hours that the battery has already been in use, up to the time that the test was initiated.

7.2.2 LED Indications with RLS Enabled

No. of Flashes	Functional Test Pass	Fail
1	0 to 59min  1hr to 1hr 59min 	121.5MHz homer 
2	2hrs to 3hrs 59min 	406MHz power 
3	4hrs to 5hrs 59min 	AIS signal 
4	6hrs to 7hrs 59min 	AIS Power 
5	8hrs to 9hrs 59min 	Battery failure 
6	10hrs + 	No GNSS 

7.2.3 LED Indications for units configured with non-RLS Protocol

No. of Flashes	Functional Test Pass	Fail
1	0 to 59min  1hr to 1hr 59min 	121.5MHz homer 
2	2hrs to 3hrs 59min 	406MHz power 
3	4hrs to 5hrs 59min 	AIS signal 
4	6hrs to 7hrs 59min 	AIS Power 
5	8hrs to 9hrs 59min 	Battery failure 
6	10hrs + 	No GNSS 

-  Because this test transmits a short burst on the aircraft distress frequency of 121.5MHz, please only carry out this test in the first 5 minutes of each hour.
-  The battery must be replaced either prior to the expiry date shown on the rear label or after the EPIRB3 Pro has been activated.
-  If, during a self test, the LED flashes magenta  or amber  the EPIRB3 Pro may not have sufficient energy to operate for the specified 24-hour period. Battery replacement is recommended.

NOTE: The flash sequence will be repeated after a short pause and then the EPIRB3 Pro will automatically power off.

7.2.4 AIS Test

Two AIS transmissions will occur during a Functional Test indicating “EPIRB TEST” on AIS receivers within range.





-  To visualise an indication of a successful AIS transmission during test always ensure the AIS receiving unit is configured to react to EPIRB Test signals.



7.3 GNSS Test





This test should only be performed where the EPIRB3 Pro3 has a clear and unobstructed view of the sky. This is required to allow the GNSS receiver to acquire a signal from sufficient satellites to allow it to determine a position. Ensure the area marked “GNSS Antenna” is not obstructed.

It is recommended that a GNSS test is carried out at least once every six months to ensure correct operation of the EPIRB3 Pro.

Press and hold the TEST  key for 5 seconds. The LED will illuminate red  to indicate the key has been pressed, then start flashing. Shortly after, the LED will cease flashing and become a steady red  light. Release the TEST  key now.



During the GNSS test the LED will repeat a long red  flash followed by a short green  flash until either a position fix is obtained or the GNSS test fails.

A successful test will be indicated by a number of green  LED flashes and an unsuccessful test will be indicated by a number of red  LED flashes. The number of flashes indicates the number of GNSS tests remaining (e.g. 7 flashes = 7 tests remaining).

The test result flashes will be repeated after 2 seconds.

If there are 10 or more tests remaining then the LED will flash 10 times only (repeated).

The EPIRB3 Pro has the capacity to carry out 60 GNSS tests within the lifetime of the battery.

If there are no tests remaining immediately after the current test, the LED will flash green  or red  rapidly for three seconds (not repeated) depending on whether the GNSS test was successful or not, respectively.

When there are no tests remaining, the LED will flash red  rapidly for three seconds (not repeated).

The test can be ended at any time by holding the TEST  key for three seconds.

For further information regarding Self Test and Self Test history use the Ocean Signal App to connect to your EPIRB3 Pro using Near Field Communication (NFC).

Android



iOS



8. BEACON REGISTRATION

⚠ It is the owner's responsibility to register this beacon with the appropriate National Authority before operation.

Documentation is provided within the packaging with information regarding registration with the relevant body to comply with the required configuration of the beacon.

NOTE: For all countries listed below it is preferred that registration is completed on-line using the appropriate links.

8.1 Advice to owners of EPIRBs

Registration of 406 MHz satellite EPIRBs:

- Registration with the National Authority is mandatory because of the global alerting nature of the system.
- The information provided in the registration card is used for rescue purposes only.
- See the owner registration card for the National Authority contact details on how to register your beacon upon completion of the sales transaction. Before a beacon enters service, it should be registered with the National Authority.
- If the beacon is being transferred to a new owner, the current owner needs to inform the National Authority of the name and address of the new owner.
- The subsequent owner of the beacon is required to provide the National Authority with the information as shown in the owner registration card.
- This obligation transfers to all subsequent owners.

8.2 Country Specific Registration Information

USA

NOAA-Sarsat, USMCC, NSOF, E/SP053, 1315 East West Hwy, Silver Spring, MD, 20910
Fax: (1.301) 8174565, Tel: (1.301) 8174515 (1.888) 2127283
Email: beacon.registration@noaa.gov, Web: www.beaconregistration.noaa.gov/

CANADA

Beacon Registry, CMCC Trenton, 8 Wing Trenton, Box 1000 Stn Forces, Astra, Ontario, K0K 3W0
Fax: +1 877 406 3298, Tel: +1 800 211 8107 / +1 613 965 7265
Email: cbr@sarnet.dnd.ca, Web: www.cbr-rcb.ca

UK

Distress & Security Beacon Registry, Pendennis Point, Castle Drive, Falmouth, TR11 4WZ
Fax: +44 (0) 13 2631 9264, Tel: +44 (0) 20 3817 2006
Email: ukbeacons@mcga.gov.uk, Web: www.gov.uk/406beacon

AUSTRALIA

Australian Maritime Safety Authority, GPO Box 2181, Canberra, Australia, ACT 2601
Fax: 1800 406 329 (+61 2 9332 6323 (Int.)), Tel: 1800 406 406 (+61 2 6279 5766 (Int.))
Email: ausbeacon@amsa.gov.au, Web: www.amsa.gov.au/beacons

NEW ZEALAND

JRCC NZ, Avalon Studios, Percy Cameron Street, P.O. Box 30050, Lower Hutt, 5040
Fax: +64 4 577 8041, Tel: +64 4 577 8030 +64 4 577 8034
Email: 406registry@maritimenz.govt.nz, Web: www.beacons.org.nz

For other countries visit: www.406registration.com/countriesupported.aspx

8.3 UNREGISTERED BEACON





It is important to register your beacon. Operation of a beacon that is unregistered or incorrectly registered could lead to delays in providing the rescue services required by the operator of that beacon.

9. APPENDIX

9.1 Maintenance

EPIRBs require little maintenance except periodic cleaning, if required. Always use a damp cloth to clean the case and dry thoroughly.

-  **Do not use solvents or other cleaning fluids as this may cause the plastics to deteriorate.**
-  **Ensure the antenna is clean and not permanently bent.**
-  **Should the EPIRB turn on during cleaning, make sure it is turned off as quickly as possible by pressing and holding the ON/OFF Key until the LED flashes red twice and release.**

9.1.1 Every Month

During the EPIRB self test it is advised that the following inspection is performed.

- Inspect the EPIRB for obvious signs of damage including the state of the antenna. Any creases in the antenna may cause operation of the EPIRB to be impaired.
- Confirm that the EPIRB is securely mounted in the Auto Release Housing.
- Inspect the lanyard to ensure it is not attached to any structures.
- Confirm the battery is within the specified expiry date.
- Confirm the HRU is within the specified expiry date (Two years after the installation date).
- Clean the EPIRB and mounting. It is recommended that the EPIRB is cleaned only using a damp cloth.

9.1.2 Every 12 Months

- Annual Test and Inspection:
Perform extended annual test according to IMO's MSC/Circ.1040 of 406 MHz satellite EPIRBs as required by SOLAS IV/15.9 (If required by SOLAS or national regulation)
- Perform a GNSS Test (see section 7.2)

9.1.3 Shore Based Maintenance (SBM)

- If the EPIRB is fitted on a vessel which requires GMDSS compliant equipment, the EPIRB shall be serviced, tested and approved as required by SOLAS regulation IV/15.9.2 of SOLAS 1974 as amended with, in accordance with MSC/Circ.1039 guidelines for shore-based maintenance of Satellite EPIRBs within 5 years, or by the date of battery expiry, whichever comes first.







There are no user serviceable parts inside the EPIRB3 Pro.



DO NOT OPEN THE EPIRB, DOING SO WILL INVALIDATE THE WARRANTY AND MAY CAUSE FALSE ALERTS





9.2 Batteries

The EPIRB3 Pro contains Lithium iron batteries for long operating life. The battery must be replaced either prior to the expiry date or after the EPIRB3 Pro has been used, even if only activated for a short period of time. The battery condition can be determined by carrying out the Self Test procedure shown in section 7 of this manual.

-  **Battery replacement must be carried out at an Ocean Signal authorised battery replacement centre using manufacturer supplied battery components.**
-  **DO NOT ATTEMPT TO REPLACE THE BATTERIES YOURSELF**
The EPIRB3 Pro is a life saving device and unauthorised opening and battery replacement may cause the unit to fail upon activation putting your life at risk.
-  **Contains Lithium batteries:**
 - store between -30°C (-22°F) to +70°C (+158°F)**
 - If the EPIRB3 Pro is stored at higher temperatures the battery life may be degraded and should be replaced earlier than the date stated. Storing outside this temperature range may result in the EPIRB3 failing to fulfil the stated 48hr operating life. The effect is more pronounced as the temperature increases.
-  **Do not short circuit, incinerate or recharge.**

9.3 Decommissioning and Disposal

Care should be taken when disposing of your EPIRB3 Pro when it is no longer required. It is recommended to remove the battery from the EPIRB3 Pro by removing the top case and lifting clear the circuit board.

-  **The EPIRB3 Pro is not user serviceable and opening the case will invalidate the warranty.**
-  **Once removed, the battery and other components of the product should be disposed of following guidelines and laws applicable within the relevant country.**
-  **Do not short circuit, incinerate or recharge the battery.**
-  **Incorrect handling and disposal of batteries may lead to leakage and explosion.**
-  **It is the owner's responsibility to inform the National Authority under which the beacon was registered that the beacon has been decommissioned.**

9.4 Transport

When shipping your EPIRB3 Pro the following guidance and regulations should be followed, but you are advised to contact your nearest battery replacement centre or Ocean Signal prior to shipping as regulations may have changed.

- Always pack your EPIRB3 Pro securely in a stout cardboard carton. Ocean Signal advises that you keep the original packaging in case of return for service.
- For surface transport the EPIRB3 Pro may be shipped under [Special Provision 188](#).
- For air transport the EPIRB3 Pro should be shipped as category [UN3091](#) and packed under [ATA packing instruction 970 section II](#). If you are hand carrying your EPIRB3 Pro on an aircraft please contact your airline for advice.

Safety Data sheets for all Ocean Signal products can be found on the Ocean Signal website:



www.oceansignal.com/safety-data-sheets/

9.5 HRU Replacement

The EPIRB3 Pro is mounted in a Auto Release Housing which contains a HR1E Hydrostatic Release Unit (HRU). The HRU unit must be replaced two years after installation - the expiry date is marked on the HRU and on the front of the housing.

If this date has been reached, the HRU must be replaced with an Ocean Signal HR1E. Failure to do so may result in the HRU not operating correctly during an emergency situation.

Lift the release mechanism by pulling against the spring and remove the EPIRB from the housing.

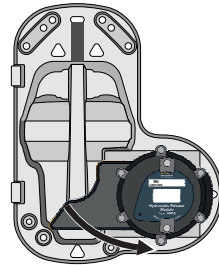

Push the HRU down against the spring and remove the locking pin. Carefully remove the HRU from the spring.

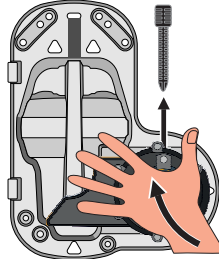

Using the new HRU, locate the two retaining ridges (at the bottom of the HRU) onto the spring. Carefully push the HRU against the spring.

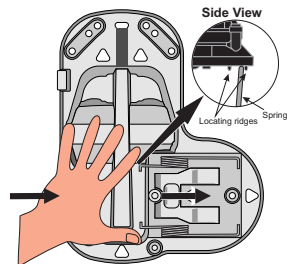

Push the HRU into position as shown. Push the locking pin home with the retaining flange pointing down. Load the EPIRB into the housing.

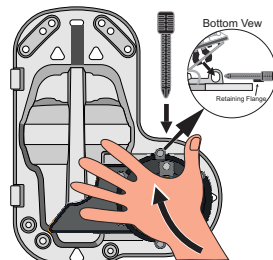

9.6 Specifications

406MHz Transmitter

Transmit Power (EIRP)	12W
Frequency	406.031 MHz \pm 1KHz
Modulation	Phase \pm 1.1 Radians (16K0G1D)
Encoding	Biphase L
Rate	400 bps

AIS Transmitter

Transmit Power (EIRP)	1Watt \pm 3dB
Frequency	161.975/162.025MHz \pm 500Hz
Baud rate	9600baud
Synchronisation	UTC
Messages	Message 1 (Position), Message 14 (Status)
Repetition interval	8 messages/minute Message 14 sent twice every 4 minutes

121.5MHz Transmitter

Transmit Power (PERP)	50mW \pm 3dB
Frequency	121.5 MHz
Modulation Duty Cycle	>35%
Modulation Factor	0.85 to1.00
Frequency Stability	\pm 50ppm
Duty Cycle	>98%

Strobe and Night Vision Lights

Light Type	High Intensity LED & Infrared (IR)
Light Colour	White and IR
Average Intensity Visible	>1 candela
Average Intensity Night Vision Light	15mW/sr
Flash Rate	24 per minute (nom.)

Battery

Type	Lithium Iron Disulphide (LiFeS2)
Operating Time	>48Hours @ -20°C
Battery Replacement Period	10 years

GNSS Receiver

Satellite Channels	72 acquisition
Sensitivity	-167dBm
Cold Start / Re-acquisition	-148dBm / -160dBm
GNSS Antenna	Microstrip Patch

General

Dimensions of EPIRB (Inc. antenna)	410mm x 90mm x 101mm (16.1 x 3.5 x 3.9 in.)
Weight (EPIRB Only)	422grams (0.92lbs)
Dimensions of Automatic Release Housing	237mm x 191mm x 121mm (9.3" x 7.5" x 4.8")
Weight (Inc. EPIRB)	1,252grams (2.76lbs)
IEC60945 Category	Portable
Operating Temperature	Class 2 -20C to +55C
Storage Temperature	Class 2 -30C to +70C
Waterproof (EPIRB)	10m depth for 1 hour
Auto Release Depth	4m maximum
Expected Life (EPIRB and Bracket)	In excess of 10 years

9.7 Approvals

In addition to Cospas Sarsat Type Acceptance, the EPIRB3 complies with the following National Approvals:

9.7.1 European Union

Complies with the requirements of the EU Marine Equipment Directive (MED)

9.7.2 UK

Complies with MSN 1874 as amended

9.7.3 USA

Complies with FCC 47 CFR Part 80 and US Coast Guard requirements

9.7.4 Canada

Compliance with ISED RSS GEN and RSS182

9.7.5 Australia/New Zealand

Complies with AZ/NZS 4280.1-2021

9.8 Spares

ARH1 Pro Replacement Automatic Release Housing	703S-03414
HR1E Replacement Hydrostatic Release Unit	701S-00608

THIS PAGE LEFT INTENTIONALLY BLANK

10. WARRANTY INFORMATION

10.1 Limited Warranty

Your Ocean Signal product is warranted against manufacturing defects in materials and workmanship for a period of 2 years from the date of purchase and in accordance with the following conditions.

Ocean Signal will at its discretion, repair or replace faulty product free of charge excluding the cost of shipping. Proof of purchase shall be required in order for a warranty claim to be valid from the original purchaser. All claims shall be made in writing to Ocean Signal or an approved service dealer or distributor.

Ocean Signal shall not be liable to the buyer under the above warranty:

- for any repairs or modifications carried out on the product using parts that are not supplied or approved by the manufacturer Ocean Signal including batteries and for work carried out other than by Ocean Signal or approved service dealers,
- for any part, material or accessory that is not manufactured by Ocean Signal the consumer will be covered by the guarantee / warranty offered to Ocean Signal by the manufacturer or supplier of such a component,
- for product which has not been fully paid for,
- for any product supplied by Ocean Signal to a customer under an alternative warranty or commercial agreement,
- for the cost of shipping product to and from the customer.

The Battery is only warranted until the date of expiry and provided the unit is tested in accordance with the information in the user manual as noted by the electronic witness stored within the product. The following specific item is excluded from this warranty:

- Damage to the antenna

This warranty does not affect your statutory rights.

10.2 Extended Warranty



ENTER YOUR PRODUCT DETAILS TO GAIN THE EXTENDED WARRANTY PERIOD

Apply for free at www.oceansignal.com/warranty

By entering your product details you can add 3 years to the warranty period.
For full details on extended warranty on this product see www.oceansignal.com/warranty.

For further assistance please contact our Technical Service Department.
Email: info@oceansignal.com

Ocean Signal Ltd.
Unit 4, Ocivan Way
Margate
CT9 4NN
United Kingdom

info@oceansignal.com
www.oceansignal.com

